

LEGEND^{NX}

LGNXT04CVWF

4.1 MP CHROMAVIEW Turret Network Camera with superior WDR, Fixed lens

- 4MP High-Resolution Imaging
- 130 dB Superior True WDR Technology
- 24/7 Colour Imaging
- Active Deterrence with Red & Blue lights
- Water and dust resistant (IP67)
- Built-in microphone, audio & alarm interface
- Advanced H.265+ Compression



In short

4MP high-resolution camera with 130 dB Superior True WDR and 24/7 color imaging. Features active deterrence with red & blue lights, IP67 water and dust resistance, built-in microphone, audio/alarm interface, and advanced H.265+ compression.

Dimensions

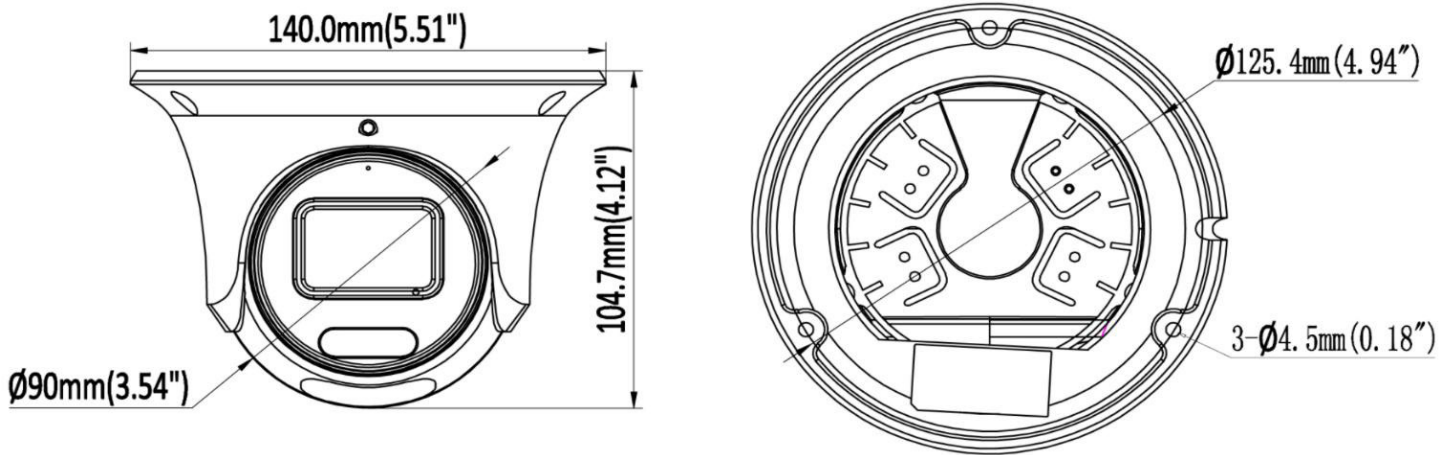

*Design and specifications are subjects to change without notice.

Technical Specifications

Camera: LGNXT04CVWF				
Image Sensor	1/1.8" Progressive Scan CMOS Sensor			
Minimum Illumination	Color: 0.0005 Lux, 0 Lux with light			
Illumination Distance	30m / 98.43ft (IR light)			
Strobe Light	N/A			
Smart IR	N/A			
Pan / Tilt / Rotation Range	Pan: 0° ~ 360° Tilt: 0° ~ 75° Rotation: 0° ~ 360°			
Lens				
Focal Length	2.8 mm			
Aperture	F1.0			
Field of View	2.8 mm: Horizontal FOV: 112°, Vertical FOV: 60°, Diagonal FOV: 131°			
Lens Mount	M16			
DORI 2.8mm	Detection	Observe	Recognize	Identify
	60m	23.5m	11.8m	5.9
Camera Image				
Maximum Resolution	4MP (2688 × 1520)			
Main Stream	50Hz: 25fps 4MP (2688 × 1520), 25fps 4M (2560 × 1440), 25fps 1080P (1920 × 1080)			
	60Hz: 30fps 4MP (2688 × 1520), 30fps 4MP (2560 × 1440), 30fps 1080P (1920 × 1080)			
Sub Stream	50Hz: 25fps 720P (1280 × 720), 25fps D1(704 × 576), 25fps CIF(352 × 288)			
	60Hz: 30fps 720P (1280 × 720), 30fps D1 (704 × 480) , 30fps CIF (352 × 240)			
Third Stream	50Hz: 25fps CIF (352 × 288)			
	60Hz: 30fps CIF (352 × 240)			
Image Setting	Brightness / Contrast / Saturation / Hue / Sharpness			
Shutter Time	Auto/Manual, 1/3 ~ 1/100000s			
Day/Night	Color Imaging, 24/7			
Wide Dynamic Range	130 dB			
Digital Noise Reduction	2D/3D DNR			
BLC	Supported			
HLC	Supported			
ROI	Supported			
Rotate	Supported			
Compression				
Video Compression	H.264 / H.264+ / H.265 / H.265+ / MJPEG			
H.264 Codec Profile	Base / Main / High profile			
H.265 Codec Profile	Main Profile			
Video Bit Rate	11 Kbps ~ 10 Mbps			
Triple Streams	Supported			
Audio Compression	G.711A, G.711U			
Audio Bit Rate	64 Kbps			

*Design and specifications are subjects to change without notice.

Technical Specifications

Smart Features	
Basic Events	Motion detection, Video Tampering
Smart Events	Smart Motion Detection, Line Crossing, Intrusion Detection, Monitoring entry and exit for specific regions ((with alarm triggers for human and vehicle detection) and Scene Alteration Detection
Face Detection	Supported
Network	
Network Storage	NAS (NFS, SMB/CIFS), ANR
Protocols	TCP/IP, ICMP, HTTP, HTTPS, FTP, DHCP, DNS, DDNS, RTP, RTSP, RTCP, NTP, IGMP, UPnP, SMTP, UPnP-TM, P2P
System Compatibility	Onvif (Profile S, Profile G, T), SDK
Security	Password protection, complex passwords, HTTPS encryption, IP address filtering, basic and digest authentication for HTTP/HTTPS, TLS 1.1/1.2, WSSE and digest authentication for Open Network Video Interface
Users	Maximum 40 users
Web Browsers	Plug-in required live view: IE 10, IE 11 Local service: Chrome 57.0+, Firefox 52.0+
Mobile Surveillance	iOS, Android
Hardware	
Communication interface	1 RJ45 10 M/100 M self-adaptive Ethernet port
Storage	Up to 256GB
Microphone	Supported
Speaker	N/A
Audio I/O	1/1
Alarm I/O	1/1
Reset button	Supported
General	
Operating Conditions	-40°C ~ 60°C (-40°F ~ 140°F) Humidity 95% or less (non-condensing)
Power Supply	DC12V ± 25%
PoE	PoE (802.3 af)
Power Consumption	Less than 7W
Protection Level	IP67
Material	Metal
Dimensions	Φ 140 × 104.7 mm (Φ 5.51" × 4.12")
Gross Weight	1.92lb / 870g

*Design and specifications are subjects to change without notice.

What you may need



XLGNXLB12C
Junction Box
Φ142 mm × 46.5mm



XLGNXPM03
Pole Mount
Φ170mm × 135.8mm × 43.7mm



XLGNXLB07C
Wall Mount
Φ136mm × 120mm x 208mm



XLGNXCM700
Pendant Mount Bracket
Φ116 mm × 734.5 mm

Accessories Mount

XLGNXLB12C

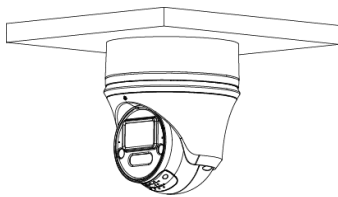

XLGNXLB07C

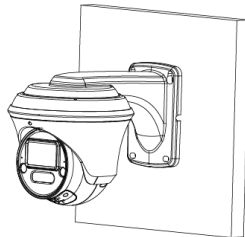

**XLGNXLB07C +
XLGNXLB12C**

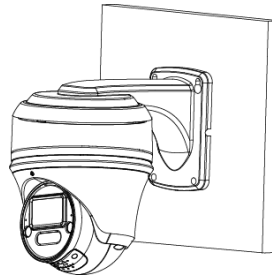

**XLGNXLB12C +
XLGNXCM700**

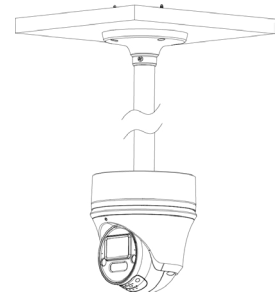

XLGNXPM03

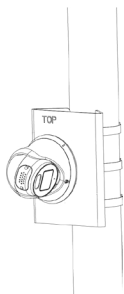

**XLGNXPM03 +
XLGNXLB12C**



**XLGNXPM03 +
XLGNXLB07C**

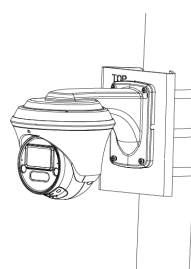

**XLGNXPM03 + XLGNXLB12C +
XLGNXLB07C**

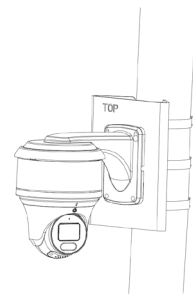

*Design and specifications are subjects to change without notice.